

# ABAQUE™

PERISTALTIC HOSE PUMP

ABAQUE  
Bulletin 1101-001 E



Where Innovation Flows



[psgdover.com/abaque](http://psgdover.com/abaque)



# Pump with Confidence

## Abaque™ Peristaltic (Hose) Pumps

With more than 20 years of experience pumping and transferring difficult chemicals and fluids, the Abaque™ Peristaltic Hose pump will handle your toughest pumping needs – from abrasive and aggressive to shear-sensitive and viscous fluids.

Abaque pumps currently operate in some of the most demanding environments including mining, water and wastewater treatment, energy, chemical processing and OEM applications.

### Durable & Rugged

The Abaque pump housing is constructed of heavy-duty ductile iron and steel and designed to provide reliable 24/7 pump operation. The pump utilizes a rugged close-coupled gear reducer.



HD20

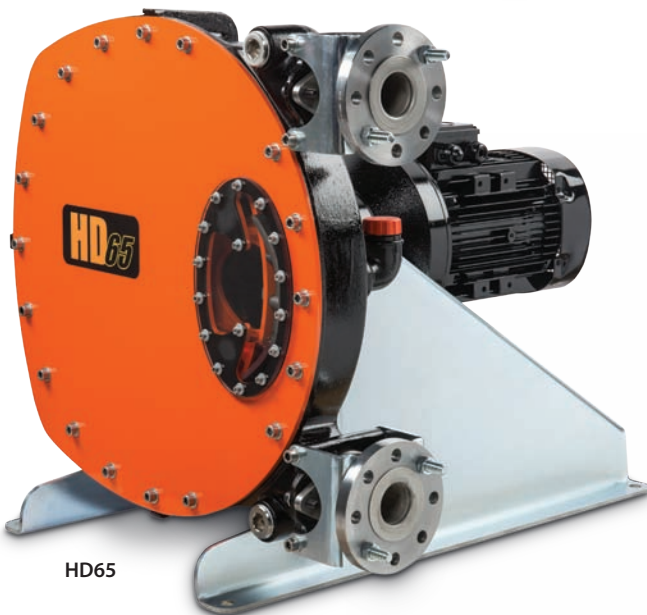

HD65



## Principle of Operation

Pumping action is achieved by compression of a circular loop of elastomeric hose with two diametrically opposed rotating shoes. With this rotational motion fluid is pushed ahead inside a hose which is compressed and relaxed by shoes mounted on a rotor. When each shoe reaches the end of the loop, the reinforced tube immediately returns to its original shape, thereby ensuring suction and priming, creating a strong vacuum pulling more fluid inside.



Resulting in:

- **High performance:** Seal-less design eliminates leaks and product contamination, and have the ability to run dry continuously without adversely affecting the pump's performance, pressure, and accuracy (no slip).
- **Reliability:** The Abaque pump has none of the usual parts that create problems on other pumps: seats, valves, mechanical seals. The hose is the only replacement part.
- **Handling of the toughest pumping challenges,** including extremely abrasive and aggressive fluids, solid loaded liquids, as well as shear sensitive and viscous materials.

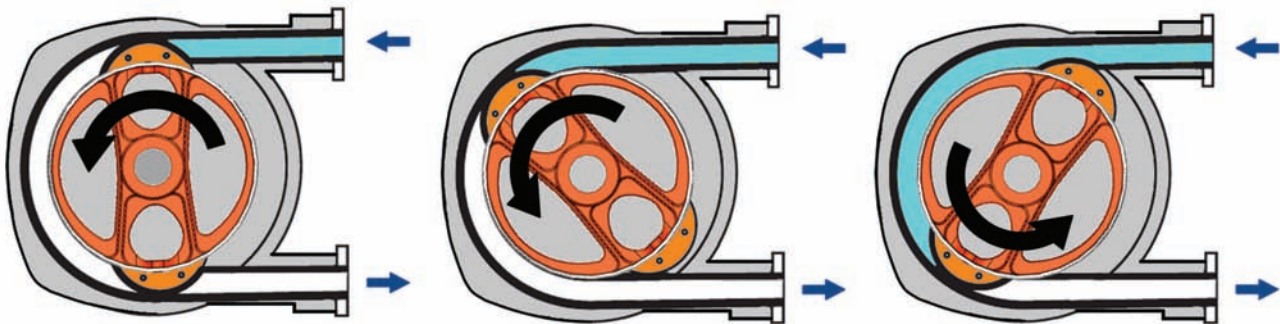

## Applications

- **Ceramic:** ceramic slips, mold filling, filter press
- **Mining:** sludge, clay slurry, lead sulfate, pyrite slurry
- **Water Treatment:** lime liquor, flocculate dispersion, sludge and slurries
- **Building Industry:** liquid or fibrous mortar, liquid plaster, light concrete
- **Chemical Industry:** acid, alcohol, detergent pumping
- **Paint & Coatings:** water base and acrylic paint, pigments, wall coating
- **Filter Press:** filling and pressing
- **Paper Industry:** latex, slurries, kaolin
- **Food Industry:** tomato sauce, mashed potatoes, gelatin, beer slurries, fish paste
- **Balneology:** thermal muds
- **Others:** glue, liquid salt, seed fertilizer





**Construction**

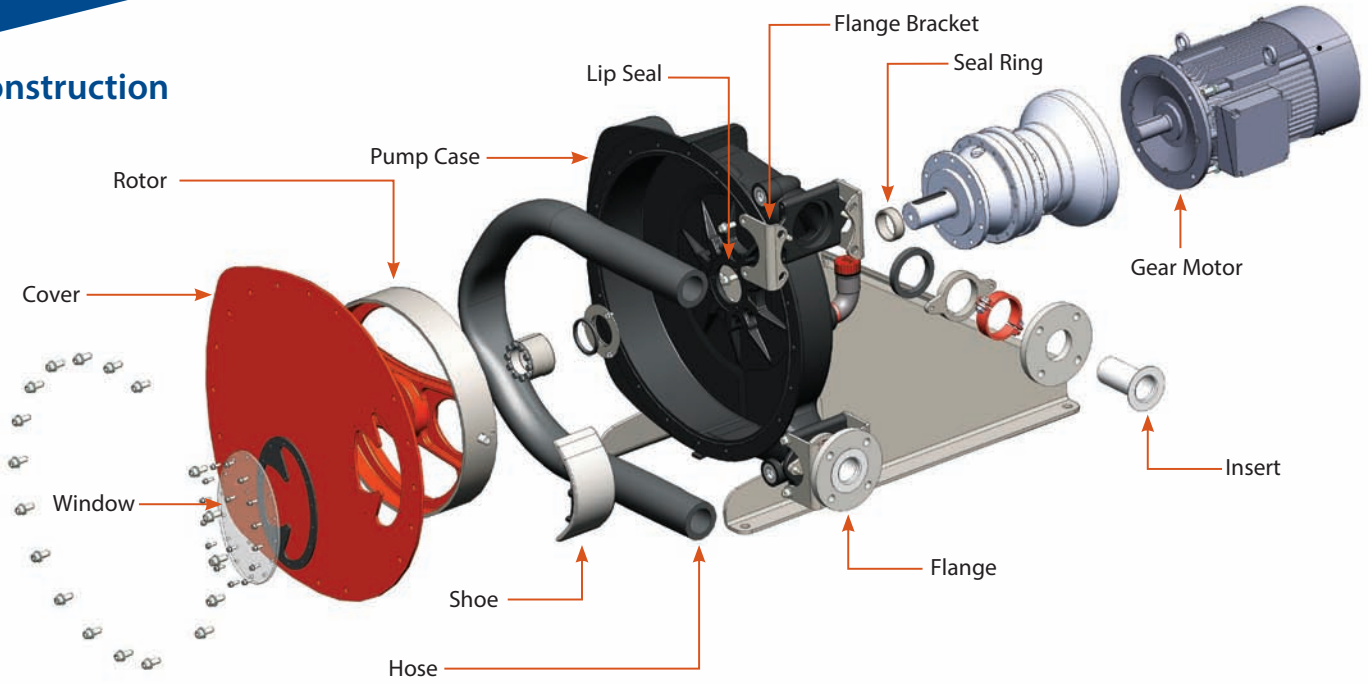

**Abaque Series Pump Construction**

<b>Pump Case:</b>	Ductile iron	<b>Flange and Brackets:</b>	Stainless steel - ANSI or DIN
<b>Wheel:</b>	Ductile iron	<b>Hoses:</b>	Natural rubber, Buna (NBR), EPDM or Hypalon®
<b>Shoes:</b>	Aluminum or cast iron	<b>Hoses inserts:</b>	Stainless steel (std.), PPH or PVDF
<b>Cover:</b>	Steel and Plexiglas		





HDX40

## Options

The Abaque Series pump is available in thirteen different sizes, ranging from flow rates of 15 to 77,000 L/hr (.07 to 339 gpm).

Also available:

- Leak detector
- Vacuum kit
- Non-metallic inserts (PPH, PVDF)
- Pulsation dampener

## Hoses

The following hoses are available for use in the Abaque Series pump:

- **Natural rubber:** Highly resilient with excellent abrasion resistance and strength.
- **Buna (NBR):** Highly wear resistant to oily products (FDA approved).
- **EPDM:** High chemical resistance, especially with concentrated acids, alcohols, and ketones.
- **Hypalon®:** Resistant to chemicals. High resistance to oxidants, as well as to concentrated bases and acids.

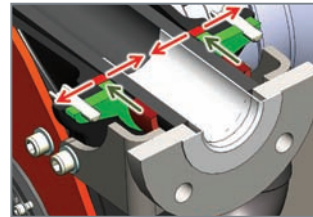

Patented Hose Holding System.

Pressing gland and square section ring provide strong hose holding and efficient tightness.



Stronger and lighter rotor design.

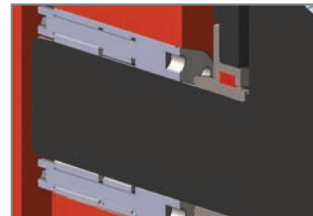

Simple, robust shaft sealing.

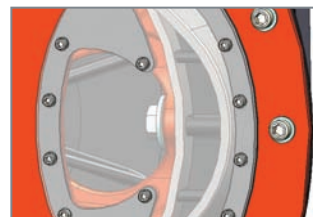

Large window allows for:

- Easy shimming of shoes
- Shoe removal without dismantling cover
- Ease of vacuuming pump body



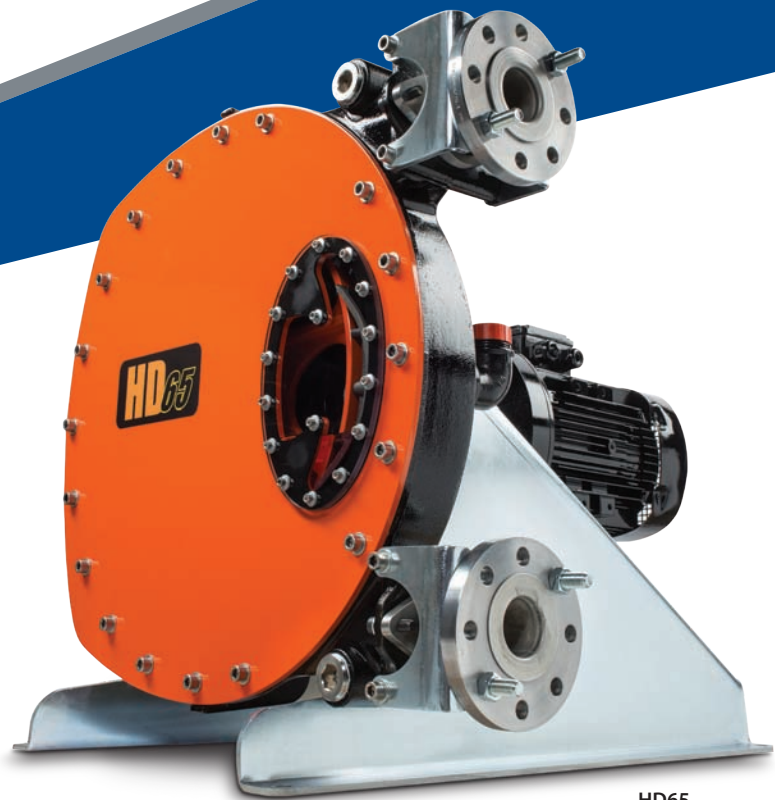

HD65



## Durable

Ductile iron and steel construction allow higher discharge pressures to 16 bar (232 psi). Its solid construction and advanced design also reduce maintenance and repairs.

## Reliable

The Abaque Series pump is self-priming to 9.5 m (32.8 ft) manometric lift. This pump is able to run dry continuously without detrimental effects. The pump is capable of running in forward or reverse.

## Seal-Free

Seal-free design eliminates leaks and contamination. Fluids are contained within the hose. The hose is the primary maintenance component.

## Performance Data

			HD10	HD15	HD20	HD25	HD32	HD40	HDX40	HD50	HD65	HDX65	HDX80	HD80	HD100
Maximum flow rate	Intermittent	l/h	135	450	750	2,670	5,300	7,200	9,600	15,300	18,200	26,000	37,300	39,000	54,000
		gpm	0.59	1.98	3.30	11.76	23.34	31.70	42.27	67.36	80.13	114.47	164.23	171.71	237.75
	Continuous	l/h	105	340	580	1,670	3,200	4,650	6,400	9,300	12,150	17,500	21,300	26,000	36,000
		gpm	0.46	1.50	2.55	7.35	14.09	20.47	28.18	40.95	53.49	77.05	93.78	114.47	158.50
Maximum differential pressure		bar	7.5	7.5	7.5	16	16	16	16	16	16	16	16	16	16
		psi	109	109	109	232	232	232	232	232	232	232	232	232	232

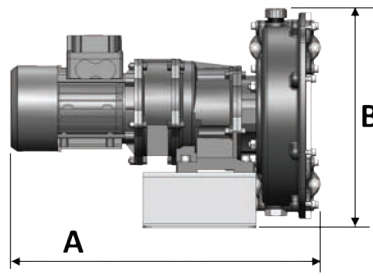
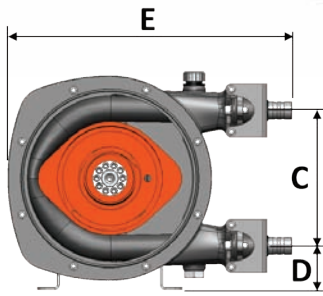
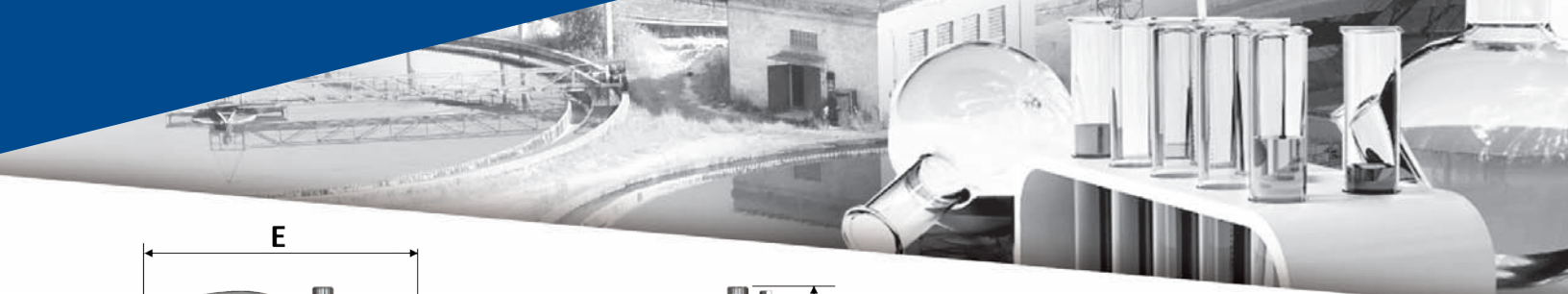

HD10, HD15, HD20

HD25, HD32, HD40, HDX40

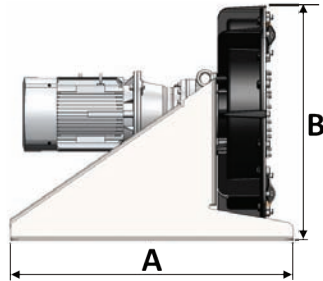
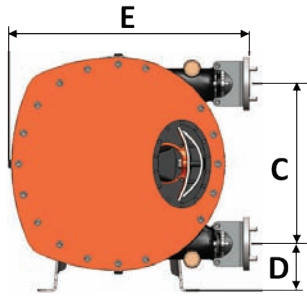
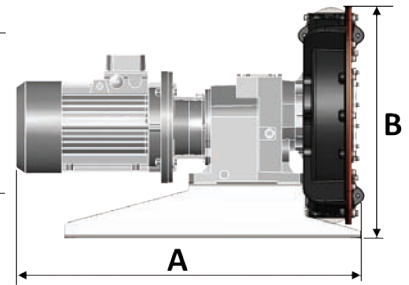
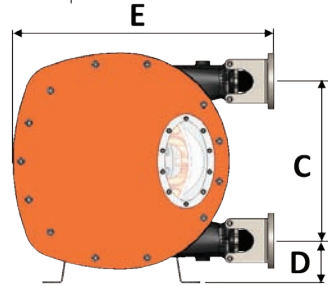

HD50, HD65, HDX65, HDX80, HD80, HD100

### Dimensions

		HD10	HD15	HD20	HD25	HD32	HD40	HDX40	HD50	HD65	HDX65	HDX80	HD80	HD100
A	mm	475*	525*	525*	665	695	695	810	1,020	1,020	1,300	1,300	1,400	1,540
	in	18.7*	20.7*	20.7*	26.18	27.36	27.36	31.89	40.16	40.16	51.18	51.18	55.12	60.63
B	mm	235	325	325	430	515	515	625	825	825	1,035	1,035	1,300	1,545
	in	9.25	12.8	12.8	16.93	20.28	20.28	24.61	32.48	32.48	40.75	40.75	51.18	60.83
C	mm	115	192	192	262	330	330	430	554	554	746	746	876	1,040
	in	4.53	7.56	7.56	10.31	12.99	12.99	16.93	21.81	21.81	29.37	29.37	34.49	40.95
D	mm	70.5	62	62	98	100	100	115	164	164	186	186	262	300
	in	2.8	2.44	2.44	3.86	3.94	3.94	4.53	6.46	6.46	7.32	7.32	10.31	11.81
E	mm	310	405	405	500	620	620	706.5	835	835	1,075	1,075	1,340	1,520
	in	12.2	15.94	15.94	16.68	24.41	24.41	27.81	32.87	32.87	42.32	42.32	52.76	59.84
Weight	kg	18 - 20	26 - 32	26 - 32	71 - 83	108 - 118	113 - 123	175 - 200	295 - 345	300 - 350	625 - 635	635 - 645	875 - 965	1,175 - 1,265
	lbs	40 - 44	57 - 70	57 - 70	156 - 183	238 - 260	249 - 271	389 - 441	650 - 760	661 - 772	1,378 - 1,400	1,400 - 1,422	1,930 - 2,127	2,590 - 2,789

\* May vary, depending on gear reducer and motor.



**PSG Auxerre**

ZI la Plaine des Isles, 2 rue des Caillottes  
F-89000 AUXERRE - FRANCE  
T +33 (0) 3 86 49 86 30 • F +33 (0) 3 86 46 42 10

**PSG California**

22069 Van Buren Street  
Grand Terrace, CA 92313, USA  
T +1 (909) 422-1730 • F +1 (909) 783-3440

[psgdover.com/abaque](http://psgdover.com/abaque)

## Where Innovation Flows



PSG reserves the right to modify the information and illustrations contained in this document without prior notice. This is a non-contractual document. 10-2019

Authorized PSG Partner: