

Neptune™

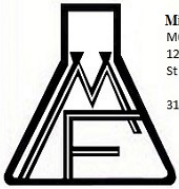

Missouri Filter & Process Equipment Co
MOFILCO-Quality, Value, Service
12025 Manchester Road, Suite 30G
St Louis MO 63131

314-821-4321 www.mofilco.com
mofilco@mofilco.com

Series PZ/ PW/PZi/PZiG Pulse Metering Pumps

BULLETIN
PZ-17



Where Innovation Flows

neptune1.com

ELECTRONIC DIAPHRAGM METERING PUMPS

a **DOVER** company

TYPE PZ
(manual)



TYPE PW
(automatic-
PWM model
shown)



TYPE PZi8
(programmable)



Features

	TYPE ▶	MANUAL CONTROL		EXTERNAL INPUT	PROGRAMMABLE INPUTS/ OUTPUTS		
		PZ	PZD	PW	PZi4	PZi8	PZiG
Manual control	• PZ Models (Speed only is adjustable from 15 to 300 SPM)	■	—	—	—	—	—
	• PZD/PW/PZi Models (Adjust speed 1 to 300 SPM plus stroke-length adjustment ¹)	—	■	■	■	■	■
	• Enter desired flow directly in ml/min.	—	■	■	—	■	■
Calibration function	• Calibrate pump flow to actual condition of chemical, pressure, viscosity, etc.	—	■	—	—	■	■
Control input	• External interlock (Examples: level switch, remote start, reset)	—	—	■	■	■	■
Operation display	• Indicates speed and status	—	—	■	■	■	■
	• Indicates speed, feed rate², status and other operational data	—	—	—	—	■	■
Signal input³ 4-pin connector	• Pulse signal Frequency-divide 1/1 to 1/9999, Multiply 1 to 9999 (See page 6)	—	—	PWP⁶	■	■	■
	• Analog signal Shift function, proportional band function (See page 6)	—	—	PWM	■	■	■
	• pH Control/Residual Chlorine Control (See page 10)	—	—	—	—	—	■
Signal output⁴ 8-pin connector	• Alarm output (Level switch, injection monitor ²)	—	—	■	—	■	■
	• Operation pulse signal (Synchronous pulse output for each stroke)	—	—	■	—	■	■
	• Operation progress signal (Time or number of strokes remaining in program)	—	—	—	—	■	■
Alarms	• Alarm display, output and action (run, pause or stop) can be selected	—	—	⁷	—	■	■
Other functions	• Two-point level control (See page 11)	—	—	—	—	■	■
	• Power supply for flow checker	—	—	—	—	■	—
	• Interval operation (Repeat cycle program, see page 11) ON time: 1 to 999999 minutes / OFF time: 1 to 999999 minutes	—	—	PWT⁸	—	■	■
	• Counter (Countdown batch injection, see page 11) 1 to 9999 strokes (X1, X10, X100, X1000)	—	—	—	—	■	■
	• Head can be turned 90° to allow base to be mounted to a vertical wall⁵	■	—	■	■	■	—

- NOTES: 1. PZi4 and PZi8 Models in sizes -32 / -52 plus all PZD and PZiG Models: 20-100% stroke-length adjustment. PW Models: 50-100% stroke-length adjustment.
 2. PZi8 only when used with Flow Checker shown on page 5.
 3. PZi4 has one analog input and one high-speed digital pulse input; PZi8 and PZiG have one analog input and two high-speed digital pulse inputs. See page 11.
 4. Two separate configurable outputs, either open collector (alarm, error, run) or pulse (operational sync or end of cycle).
 5. Sizes -31 / -61 / -12 only. 6. Pulse Signal Frequency: divide 1/1 to 1 to 999; multiply 1 to 999 (Model PWP).
 7. Alarm output with level device or high pressure.
 8. Internal Operation: on time 1 to 9,999 minutes; off time 9,999 minutes (Model PWT).

Model Number Selection *The complete model number consists of three parts: TYPE + SIZE + MATERIAL CODE*

TYPE – TYPE – Specify **PZ** or **PZD** for manual control; specify **PZi4** or **PW** for external input; specify **PZi8** for programmable models. The largest models are the **PZiG** Series, available in full-programmable type only.

SIZE – Size code selects the capacities per the charts on pages 3 and 4. Sizes **-31**, **-61** and **-12** are available for type PZ and PW. Higher capacity sizes **-32** and **-52** are available for type PZD. Types PZi4 and PZi8 are not available in sizes -31, -61 or -12. The very high PZiG capacities are shown in a separate chart.

MATERIAL CODE – Select from charts on pages 3 and 4.

Example – The complete model for a pump with a Kynar® liquid end with Viton® seals rated at 160 ml/min capable of accepting a 4-20mA input would be:

Type **PWM** + Size **-61** + Material code **-FTCT**
 The complete model number becomes
PWM-61-FTCT

Variety of Liquid-End Materials

Standard Model: PVC (VTCF/VTCE)

- General chemical applications
- Valve seats and O-rings are available in Viton® or EPDM
- Built-in relief valve



Universal Model: PVDF (FTCF/FTCE/FTCT)

- For most chemicals and highly corrosive chemicals
- Valve seats and O-rings are available in Viton®, EPDM or Teflon®
- Built-in relief valve



Stainless Steel Model (SS)

- For solvents and other chemicals where plastics are not suitable



Chlorine Model: Acrylic (CL)

- Transparent pump head allows visual check of valves
- Reduced head volume and upward sloping ports vent gas away from diaphragm
- Improved pump efficiency for countering gas lock
- Built-in relief valve



Chlorine Model: Acrylic (ARPZ)

- CL model with automatic air-release mechanism
- Derate capacity 5% for air-release models

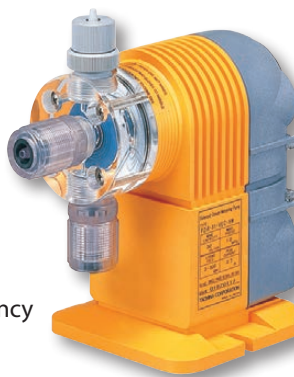

*Not available for PW models

To specify pump, choose the type from the chart on page 2 plus the size from the chart below (ex: PZi4-32). Then add the appropriate material code from the chart below (ex: PZi4-32-FTCF). Complete instructions regarding Model Number Selection are on page 2.

Materials Chart: PZ / PW / PZD / PZi4 / PZi8

Adapters for NPT connection are available

MATERIAL CODE	PUMP HEAD	TUBE JOINT	VALVE SEAT	CHECK BALL	DIAPHRAGM	FOOT VALVE & STRAINER	BACKPRESSURE INJECTION ASSEMBLY	SUCTION CONNECTION - TUBE*	DISCHARGE CONNECTION - TUBE*
VTCF	PVC	PVC	Viton®	Ceramic	PTFE	PVC	PVC	3/8" Tube - Soft PVC ²	3/8" Tube - PE ²
VTCE	PVC	PVC	EPDM	Ceramic	PTFE	PVC	PVC	3/8" Tube - Soft PVC ²	3/8" Tube - PE ²
CL ¹	Acrylic	PVC	Viton®	Ceramic	PTFE	PVC	PVC	3/8" Tube - Soft PVC	3/8" Tube - PE
ARPZ ¹	Acrylic	PVC	Viton®	Ceramic	PTFE	PVC	PVC	3/8" Tube - Soft PVC	3/8" Tube - PE
SS	316SS	N/A	EPDM	316SS	PTFE	Not Included	Not Included	3/8" MNPT - None	3/8" MNPT - None
FTCF ¹	PVDF	PP	Viton®	Ceramic	PTFE	PVDF - Molded	PVDF - Molded	3/8" Tube - PE ³	3/8" Tube - PE
FTCE ¹	PVDF	PP ⁴	EPDM	Ceramic	PTFE	PVDF - Molded	PVDF - Molded	3/8" Tube - PE ³	3/8" Tube - PE ⁴
FTCT	PVDF	PVDF	Teflon®	Ceramic	PTFE	PVDF - Molded	PVDF - Machined	3/8" Tube - FEP ^{2,3}	3/8" Tube - FEP ²

¹ Not available in -32 or -52 size codes. PW not available in ARPZ configuration.

² PZ-32 and PZ-52 Models - 18 x12 mm Soft PVC Tube for VTCF and VTCE Models; 15 x12 mm PTFE Tube for FTCT Models

³ Ceramic Weight Included ⁴ 220 psi Model PZ/PW-31-FTCE - 1/4" Tube Joint and Tube - PP

*NOTE: 3/8" Tube is 3/8" OD x 1/4" ID; Adapters for NPT connection are available

Type and Size Selection Chart: PZ / PW / PZD / PZi4 / PZi8

Head can be turned 90° to allow base to be mounted to a vertical wall (-31 /-61 /-12 only).

MANUAL MODEL	EXTERNAL INPUT MODEL ¹	PROGRAMMABLE MODEL	GPD	MAX. CAPACITY GPH	ML/MIN.	MAX. PRES. PSI	DWG./CURVE	STROKE LENGTH (MM)	MAX. PWR. (VA)	AVG. PWR. (WATTS)
PZ-31-HP	PWM-31-HP/ PWP-31-HP/ PWT-31-HP ^{1,3}		10.5	0.44	28	290	pages 8-9	1.0	200	15
PZ-31	PWM-31/ PWP-31/ PWT-31 ¹		12	0.5	30	145	pages 8-9	1.0	200	15
PZ-61	PWM-61/ PWP-61/ PWT-61 ¹		24	1.0	60	145	pages 8-9	1.0	250	18
PZ-12	PWM-12/ PWP-12/ PWT-12 ¹		38	1.6	100	100	pages 8-9	1.0	250	18
PZD-32	PZi4-32 ¹	PZi8-32 ²	137	5.7	360	45	pages 8-9	1.5	500	30
PZD-52	PZi4-52 ¹	PZi8-52 ²	204	8.5	540	30	pages 8-9	1.5	500	30

NOTES: ¹ PW and PZi4 models provided with terminal strips, not pin connectors.

² PZi8 models include two separate 2-meter cables, one each 4-pin and 8-pin connector end.

³ High Pressure models are available as PZ-31, PWM-31, PWP-31 or PWT-31 only; available in FTCE or SS only. Refer to Material Code Chart above.

Type PZD/PZi-32/52 High-Capacity Models

PZD Series pumps offer higher capacities. These models feature an extra-large keyboard and the injection rate can be entered directly in milliliters per minute.

The injection rate can be set three ways by direct entry of:

- Stroke speed: 1 to 300 spm
- Percentage: 1% to 100%
- Injection rate: ml/min.

High-Capacity models are available in material codes VTCE, VTCE, SS and FTCT only. VTCE model is shown.

- **Onboard calibration** measures the actual discharge volume under the exact operating condition of the specific installation and chemical, then stores that value to ensure the correct injection rate.



- Manual stroke length adjustment 20% to 100%
- Set points can be easily viewed on the LCD
- Pump head may be rotated to face in any of the three positions other than where the keypad and display are located
- Pump head can be decoupled from the controller base for remote mounting

Type PZiG Programmable Large-Volume Models

PZiG Models offer capacities typically requiring motor-driven pumps.

Special models easily handle viscosities of 1000 CPS (up to 4000 CPS at reduced volume). Powerful onboard controls allow proportional flow rate, pH and residual chlorine control by direct analog connection eliminating the PID Controller and Inverter (plus the control panel to house them), that are required by similar sized motor-driven pumps

The injection rate can be set three ways by direct entry of:

- Stroke speed: 1 to 300 spm
- Percentage: 1% to 100%
- Injection rate: ml/min.

Note: Install a pulsation dampener for discharge lines greater than 7 feet to achieve maximum pressure capability.

- Manual stroke length adjustment 20% to 100%.

Control Functions also include (see pages 10-11):

- **Onboard calibration** measures the actual discharge volume under the exact operating condition of the specific installation and chemical, then stores that value to ensure the correct injection rate
- Multi-pump proportional flow rate injection from a single direct flowmeter signal (pulse/analog)
- Two-point level switch control (see page 11)
- Two-line LCD screen displays injection rate and/or operational progress
- Batch injection
- Interval injection
- Proportional control with shift and proportional band function



PZiG with VTCE Liquid Head

Materials Chart: PZiG

MATERIAL CODE	PUMP HEAD	VALVE SEAT	CHECK BALL	DIA-PHRAGM	STRAINER	BACKPRESSURE INJECTION ASSEMBLY	SUCTION/DISCHARGE CONNECTION
VTCE	PVC	EPDM	Ceramic	Teflon®	Not Included	Not Included	1/2" FNPT
VTCE ¹	PVC	Viton®	Ceramic	Teflon®	Not Included	Not Included	1/2" FNPT
VTCE-V ¹	PVC	Viton®	Ceramic	Teflon®	Not Included	Not Included	3/4" FNPT
FTCT	PVDF	Teflon®	Ceramic	Teflon®	Not Included	Not Included	1/2" FNPT
FTCT-A ²	PVDF	Teflon®	Ceramic	Teflon®	PVDF	PVDF	15 x 12 PTFE ²

¹ High-Viscosity Model rated 1000 to 4000 cps. Consult factory for applications greater than 2000 cps.

² Only these models include Foot Valve Strainer, Antisiphon Check Valve, plus 15 x 12 mm Teflon Suction and Discharge Tubing. Tubing rated 75 psi max.

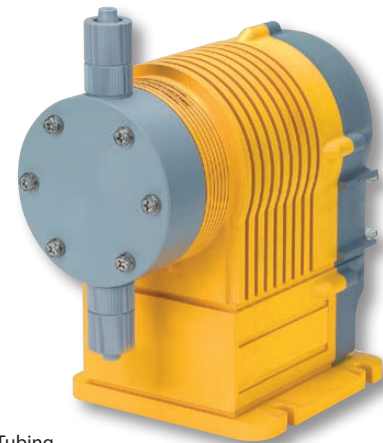

Available Only in Programmable Models

(See page 10 for Direct Connection of pH and Residual Chlorine Control Instruments)

Type and Size Selection Chart: PZiG

PROGRAMMABLE MODEL	GPD	MAX. CAPACITY GPH	ML/MIN.	MAX. PRESSURE PSI	DRAWING/CURVE	STROKE LENGTH (MM)	MAX. POWER (VA)	AVG. POWER (WATTS)
PZiG-300	130	5.4	340	140	pages 8-9	1.5	750	100
PZiG-500	200	8.4	530	100	pages 8-9	1.5	750	100
PZiG-700	288	12.0	760	60	pages 8-9	1.5	750	100
PZiG-1000	380	15.8	1000	45	pages 8-9	1.5	750	100
PZiG-1300	495	20.6	1300	30	pages 8-9	1.5	750	100

Included with Each Pump:

Foot Valve Strainer*

Back Pressure/Check Valve Injector with Quill*

Suction, Discharge and Air-Release Tubing*

Power Cord with 3-Prong Plug

Signal Cable with Multi-Pin Connectors (provided with PZiG pump models only)

*except some PZiG models (see page 4)



Foot Valve Strainer

Back Pressure Injector

Material Selection Chart

PUMPING LIQUID (in alphabetical order)	CONCENTRATION	RECOMMENDED TYPE
Acetic acid	50%	VTCT/FTCF
Acetic acid	concentrated 24°C	FTCT
Aluminum sulfate	—	VTCE
Amine*	—	SS
Aqueous ammonia	—	VTCE
Calcium/Sodium hypochlorite	12%	CL/AR
Caustic soda	—	VTCE
Ferric/Ferrous chloride	—	VTCT
Ferric/Ferrous sulfate	—	VTCT
Hydrochloric acid	10% to conc.	VTCT
Hydrogen peroxide	30%	VTCT
Nitric acid	10%	VTCT
Nitric acid	30% to conc.	FTCT
Phosphoric acid	10% to conc.	FTCT
Poly-aluminum chloride (PAC)	—	VTCE
Potassium permanganate	—	VTCE
Sulfuric acid	to 40%	VTCT/FTCF
Sulfuric acid	concentrated	FTCT

* Boiler compounds with small amounts of Amine – FTCE

Caution – All Models

- Ambient temperature: 32°F to 104°F (0°C to 40°C)
Pumped liquids:
Temperature: 32°F to 104°F (0°C to 40°C),
Viscosity: 100 CPS max. except as noted
- This pump is designed for outdoor use. Avoid installing pump in a location where service life could be shortened (i.e., where it is exposed to direct sunlight or driving rain)
- This pump cannot pump liquids containing a slurry
- A relief valve should be installed on the discharge side, if the pump does not have a built-in relief valve and the discharge piping has a shutoff valve

Feed Verification Model FC-1 Flow Checker

The Model FC-1 Flow Checker output provides vital information for water-treatment programs requiring feed verification to manage chemistry and monitor drum inventory.

- The flow checker mounts directly to the discharge of PZ, PWM, PWP and PWT metering pumps.
- The flow checker is an oval gear flow meter which measures the pump output and transmits one pulse for each 1 ml of flow.
- Connect the flow checker output to your controller or PLC (external power supply required).



(shown with PZ type pump)

Dimensions

inches (mm)

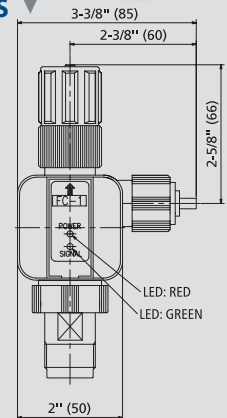

Flow Checker Selection Chart

MODEL NO.	MATERIAL	USE w/ PUMP MODEL†
FC-1P-P-N1	Ryton*	PZ or PZi-31
FC-1N-P-N1	Noryl**	PZ or PZi-31
FC-1P-P-N2	Ryton*	PZ or PZi-61 or -12
FC-1N-P-N2	Noryl**	PZ or PZi-61 or -12

† Not available for larger models

Liquid-End Materials

PART NAME	MODEL FC-1P-□	MODEL FC-1N-□
Body	Ryton*	Noryl**
Ball Check	Ceramic	Ceramic
Ball Guide/Joint	PVC	PVC
Valve Seat/O-Ring	EPDM	Fluororubber

* Ryton: PPS — Polyphenylene-sulfide (for general chemicals)

** Noryl: PPO — Polyphenylene-oxide (for sodium hypochlorite)

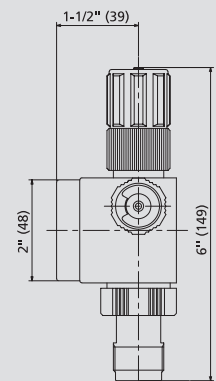

Specifications

Pulse constant	1mL/pulse
Accuracy	±3% (Depends on nature of chemical, flow rate, temperature and back pressure.)
Normal operating pressure	140 psi (10 Kg/cm ²)
Momentary maximum operating pressure	200 psi (14 Kg/cm ²)
Temperature	32°F–104°F (0°C–40°C) (Liquid should not freeze.)
Liquid viscosity	1 to 50 cps
Output	Open collector (Collector capacity: 30V, 30mA)
Power requirement	4.5 to 25VDC (20mA Max.)*

Green LED lights for each pulse output. Red LED on when the power is ON

NOTES: 1. Use flow checker only for clear liquids.

2. Pressure loss is 0.5 Kg/cm² (at maximum flow rate using water).

* + 5V Power Supply provided on board PZi8 Models.

Advantages

- Settings from 15 to 300 pulses per minute on PZ models and from 1 to 300 pulses per minute on PW, PZi and PZD models
- High stroking speed ensures more uniform distribution of chemical at low feed rates
- Pump delivery is constant at any voltage from 94 to 264 VAC single phase and is not affected by voltage fluctuations
- Outdoor use—pump is water and UV-resistant. Equivalent to IEC specification IP65. Dust-proof, wash-down duty (with proper electrical connection).



Analog Signal Input

DC4 (0) to 20mA input

PWM / PZi4 / PZi8 / PZiG

1. Proportional band function

The proportional band can be adjusted within a range of $\pm 1\%$ to $\pm 999\%$. Pump response to increasing input signal is easily reversed from min. 4mA and max. flow at 20mA to max. flow 20mA and min. flow at 4mA. 0mA to 20mA range on PZi8 models

2. Shift function

Shift can be set within the range $\pm 100\%$ allowing a min. preset flow at 0 (4mA) signal or allowing no flow until the input signal exceeds a preset value.

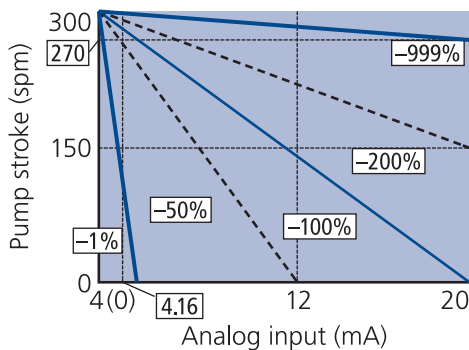
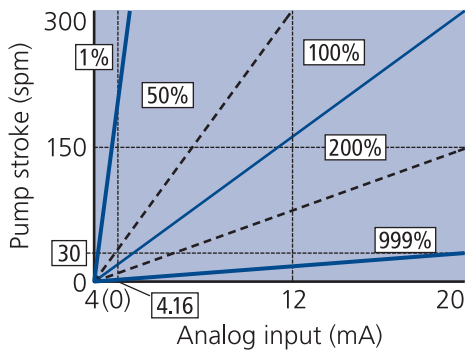
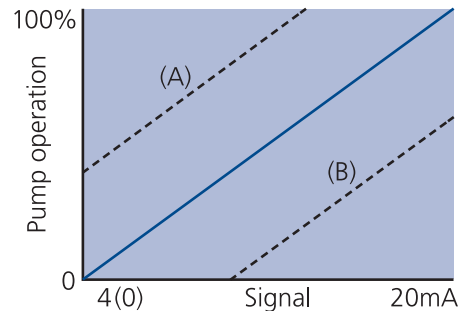

Pulse Signal Input

PWP / PZi4 / PZi8 / PZiG

1. Frequency-division (1/1 to 1/9999 adjustable)*

Example: 1/6 frequency-division

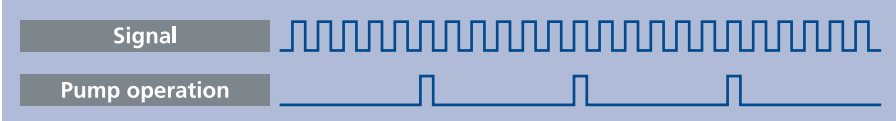

2. Multiplication (1 to 9999 adjustable)*

Example: 5 times multiplication

(A) Pulses 5 times—next 5 strokes at normal operating speed.



(B) Pulses 5 times evenly spaced over one minute.



* Frequency division and multiplication functions on PWP 1/1 to 1/999 and 1 to 999 adjustable

Applications

- Injection of chemicals to boilers and cooling towers
- Chlorine sterilization for food plants, small-scale water-supply systems, buildings and swimming pools

- Injection of nutrients and disinfectants in the livestock industry, such as poultry and hog producers, as well as for hydroponic cultivation
- Very low flow rate injection of low-viscosity liquids for any application (100 CPS max. except high-viscosity models)

TYPE PWT
with Timer Control



Timer Control

PWT

1. INTERVAL mode

Pump operation can be turned on and off in accordance with the setting of the timer. You can set any ON and OFF period for one pattern each in the range of 1 to 9999 minutes.

Setting example: ON period: 5 minutes
OFF period: 3 minutes

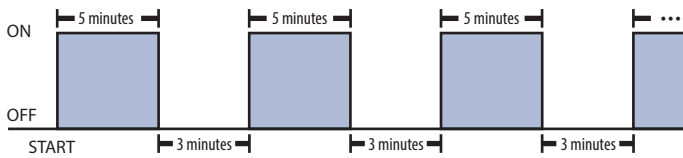

3. WEEK mode

The pump automatically operates every week at the same ON and OFF time being set for the day of the week. You can set one program pattern for each day of the week. You can set the ON time from 0:00 to 24:00 and OFF time within the range of 0:00 to 48:00 in 1-minute units.

*WEEK mode cannot be used together with DAY mode

Setting example:

		Mon		Tue		Wed		Thu		Fri		Sat		Sun		Mon		Tue	
		0:00	12:00	0:00	12:00	0:00	12:00	0:00	12:00	0:00	12:00	0:00	12:00	0:00	12:00	0:00	12:00	0:00	12:00
No. 1	Mon	ON time	9:00																
		OFF time	18:00																
No. 2	Tue	ON time	9:00																
		OFF time	24:00																
No. 3	Wed	ON time	12:00																
		OFF time	30:00																
No. 4	Thu	ON time	9:00																
		OFF time	36:00																
No. 5	Fri	ON time	12:00																
		OFF time	36:00																
No. 6	Sat	ON time	--:--																
		OFF time	--:--																
No. 7	Sun	ON time	0:00																
		OFF time	32:00																

- When the pulse proportional control operation is set, the pump will operate in accordance with the pulse frequency-division or pulse frequency-magnification set for this operation.
- When both interval mode and pulse proportional control operation are simultaneously set, the pump will operate in accordance with pulse frequency-division or pulse frequency-magnification set for this operation.*¹

*¹ The number of strokes will be the value set in each program.

The following combination of functions can also be used besides the above-mentioned combination.



4. ECO mode

ECO mode is a programmable feature that is enabled through the control panel on the PW version pumps. A green indicator lamp labeled ECO on the control panel illuminates when this feature is operative.

The factory default setting for this feature is enabled.

In the enabled mode, the pump automatically reduces the power-on time of the solenoid when the pump is injecting against low discharge pressures. This results in reduced power consumption of up to 55% when the discharge pressure is reduced to ~15 psi.

2. DAY mode

The pump operates automatically every day using the same ON and OFF timing that is set. You can set up to nine program patterns within the range of 0:00 to 24:00 in 1-minute units.

*DAY mode cannot be used together with the WEEK mode.

Setting example: ON time: 5 minutes ① 1:00 ② 6:30 ③ 11:30 ④ 17:15
OFF time: 3 minutes ① 5:00 ② 10:30 ③ 15:15 ④ 21:15

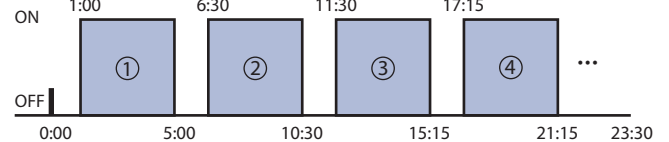

- When both interval mode and pulse operation are simultaneously set, the pump will operate in accordance with pulse frequency-division or pulse frequency-magnification setting within the ON time set for the DAY mode and interval mode.

5. SAFE mode

SAFE mode is a programmable feature that is enabled through the control panel on the PW version pumps. A green indicator lamp labeled SAFE on the control panel illuminates when this feature is operative. The factory default setting for this feature is disabled.

Since the standard PW version pumps include built-in relief-valve protection, Neptune recommends this feature remain disabled.

External Dimensions

Dimensions are shown in inches (mm).

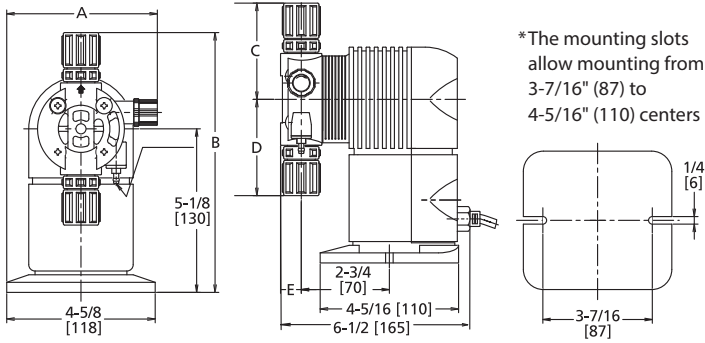

MODELS PZ					
MATERIAL	A	B	C	D	E
VTCF/VTCE	4¾ (120)	8¾ (206)	3 (76)	3 (76)	1¼ (17)
FTCF/FTCE/FTCT	4¾ (120)	9 (228)	3⅞ (98)	3⅞ (98)	1¼ (17)
CL	¾ (83)	8 (204)	2⅞ (73)	3 (76)	1¼ (32)
ARPZ	¾ (83)	8 (204)	2⅞ (73)	3 (76)	2¼ (57)
SS	¾ (83)	7⅝ (194)	2½ (64)	2½ (64)	¾ (19)

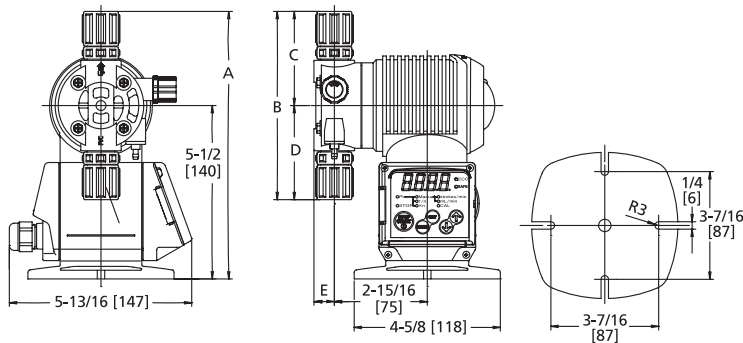

MODELS PW-31 / 61 / 12					
MATERIAL	A	B	C	D	E
VTCF/VTCE	8½ (216)	6 (152)	3 (76)	3 (76)	⅝ (16.5)
FTCF/FTCE/FTCT	9¼ (237)	7¾ (195)	3⅞ (98)	3⅞ (98)	⅝ (16.5)

*The shape and dimensions differ slightly depending on the liquid-end material and connection type

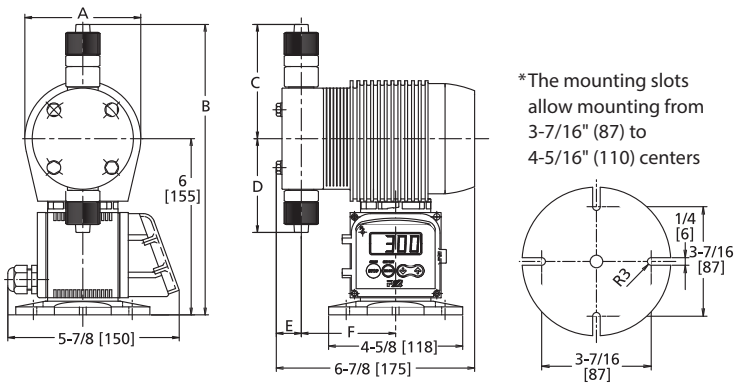

MODELS PZD / PZi-32 / 52						
MATERIAL	A	B	C	D	E	F
VTCF/VTCE	4 (102)	9⅝ (244)	3½ (88)	3½ (88)	1 (25)	3⅝ (86)
FTCT	4 (102)	10⅝ (256)	4 (101)	3¼ (83)	⅞ (22)	3¼ (83)
SS	4 (102)	9 (227)	3¼ (83)	2⅞ (72)	1 (24)	3½ (89)

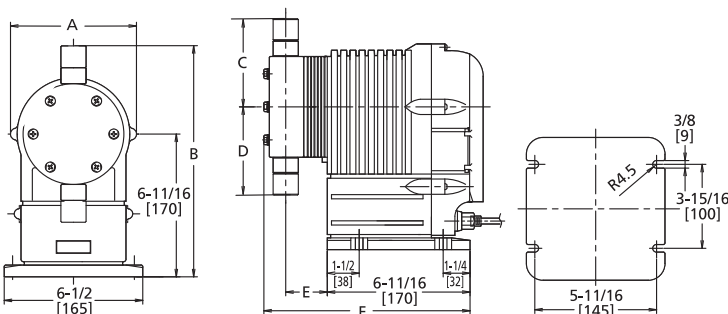

MODELS PZiG-300 / 500 / 700 / 1000 / 1300						
MATERIAL	A	B*	C*	D*	E	F
VTCF/VTCE						
300/500	5⅞ (150)	10¾ (270)	4 (100)	4 (100)	2 (50)	9¾ (247)
700	5⅞ (150)	10¼ (260)	3½ (90)	3½ (90)	2 (50)	9¾ (247)
1000/1300	5⅞ (150)	10½ (265)	3¾ (95)	3¾ (95)	2½ (54)	10 (253)
FTCT						
300/500	5⅞ (150)	11¼ (285)	4½ (115)	3⅞ (97)	2 (50)	9¾ (247)
700	5⅞ (150)	11¼ (285)	4½ (115)	3⅞ (97)	2 (50)	9¾ (247)
1000/1300	5⅞ (150)	11¾ (298)	5 (128)	5 (128)	2½ (54)	10 (253)

*For high-viscosity liquid end type VTCF-V (all sizes):
 B = 11⅝ (294) C = 4⅞ (124) D = 4⅞ (124)

Pump Head Cross-Sectional View

Cross-Sectional view applies to PVC, Kynar and Type CL Heads; does not apply to Material Codes ARPZ, SS or any PZiG Liquid Heads. Some models use single check balls.

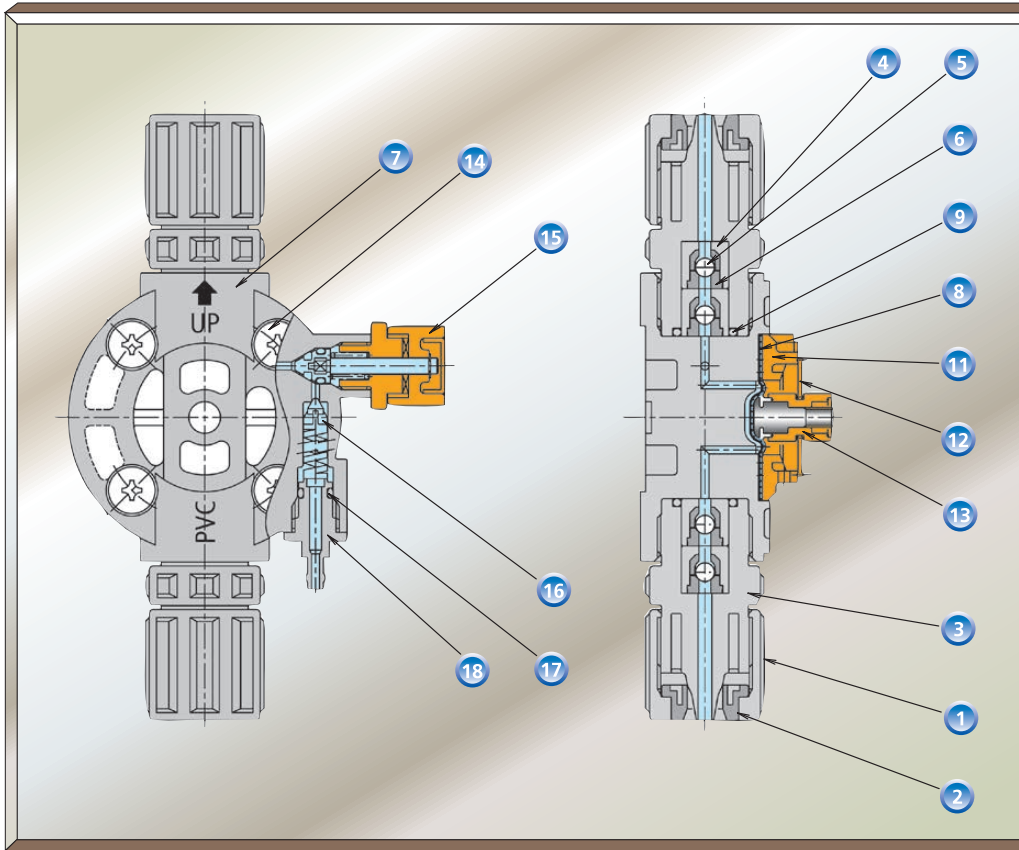

- 1 Hose Nut
- 2 Retaining ring
- 3 Hose joint
- 4 Ball guide
- 5 Check ball
- 6 Valve seat
- 7 Pump head
- 8 Diaphragm
- 9 O-ring
- 11 Support ring
- 12 Protective diaphragm
- 13 Spacer
- 14 Truss screw
- 15 Relief valve
- 16 Air-release valve
- 17 O-ring
- 18 Air-release nozzle

Performance Curves

Conditions: Clean water, Room temperature

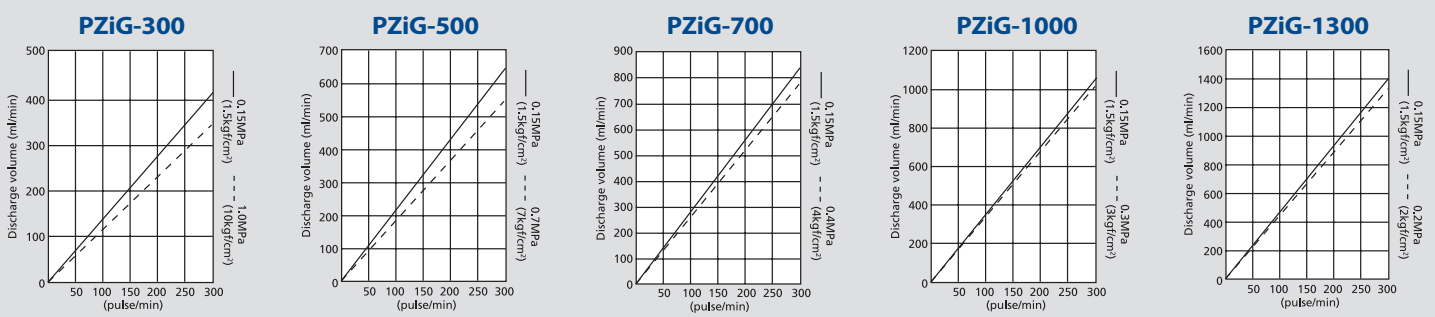
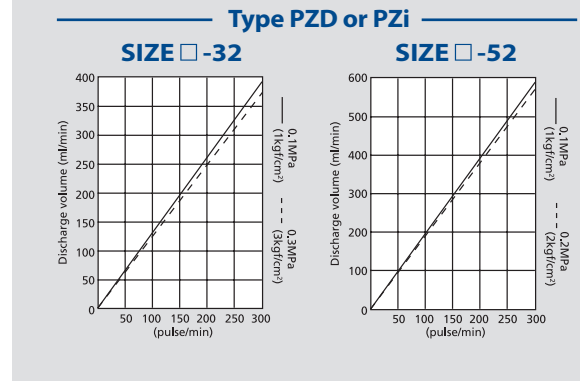
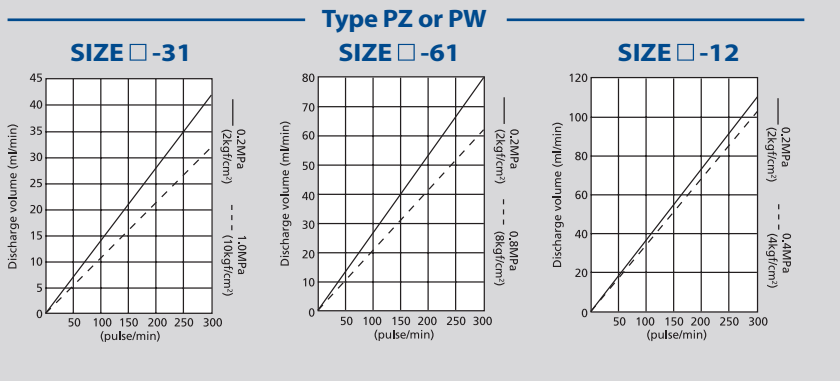

Programmable Models PZi8 and PZiG Control System Examples

Your System is Enhanced by Outstanding Controllability

Proportional Flow Rate Control – Models PZi8 & PZiG

Advantage

Flow meter signals are received directly according to the flow rate of the main piping and the discharge volume is automatically controlled. This eliminates the need for control devices, which have been needed up until now, and reduces the cost of devices.

Cost benefits: Digital panel meters, PID controllers and inverters are no longer required.

Example: Any additive injected proportional to flow in a line

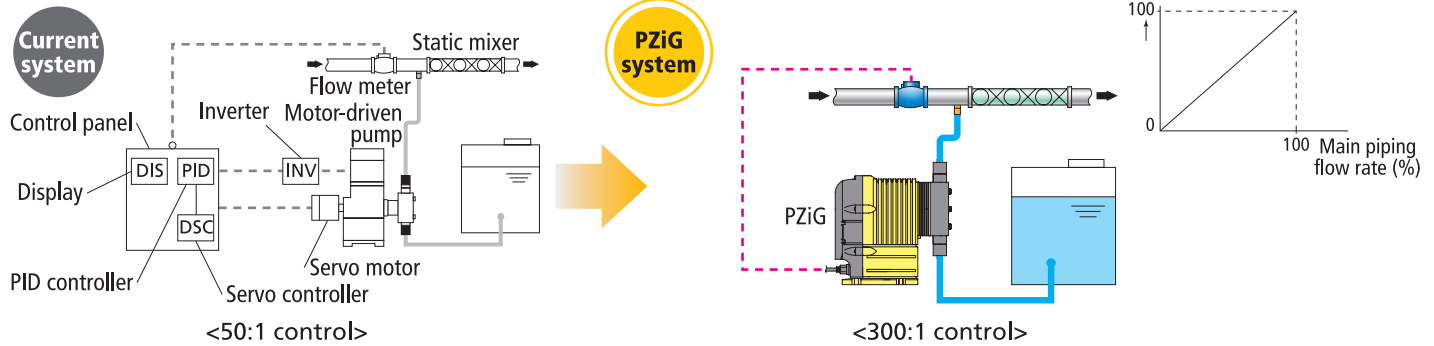

pH Control – Model PZiG only

Advantage

Control signals from the pH meter are received and chemicals are automatically injected according to the preset pH value. This simplifies the configuration of the control devices.

Cost benefits: Two PID controllers and two inverters are no longer required.

Example: On-site pH control

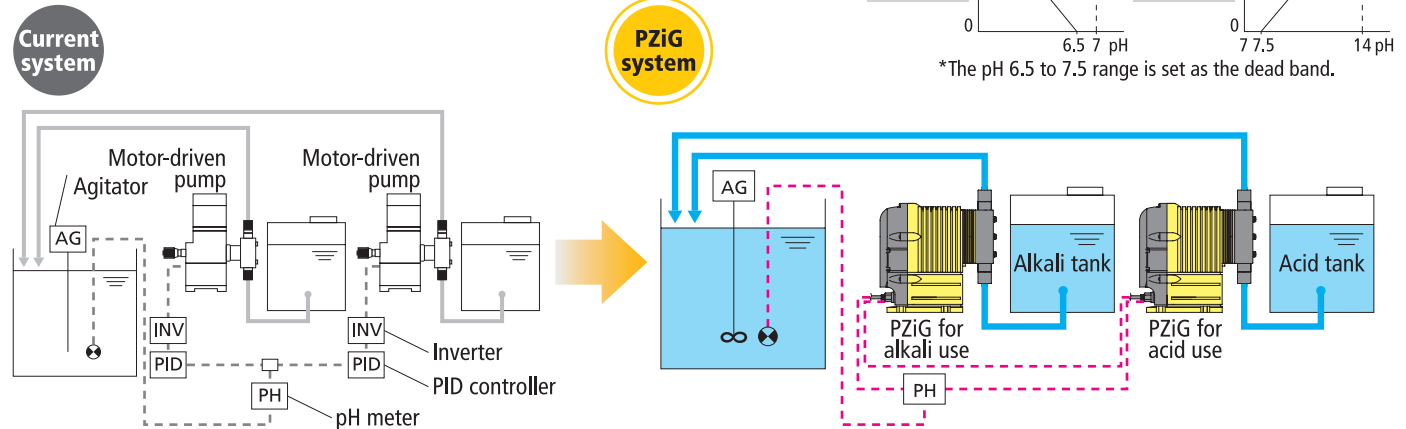

Sterilization – Model PZiG only

Advantage

Automatic control is possible on the pump unit merely by receiving signals directly from the residual chlorine meter and setting the target residual chlorine value.

Cost benefits: Control panels (PID controllers and inverters) are no longer required.

Example: Disinfection using electrolytic sodium hypochlorite in swimming pools

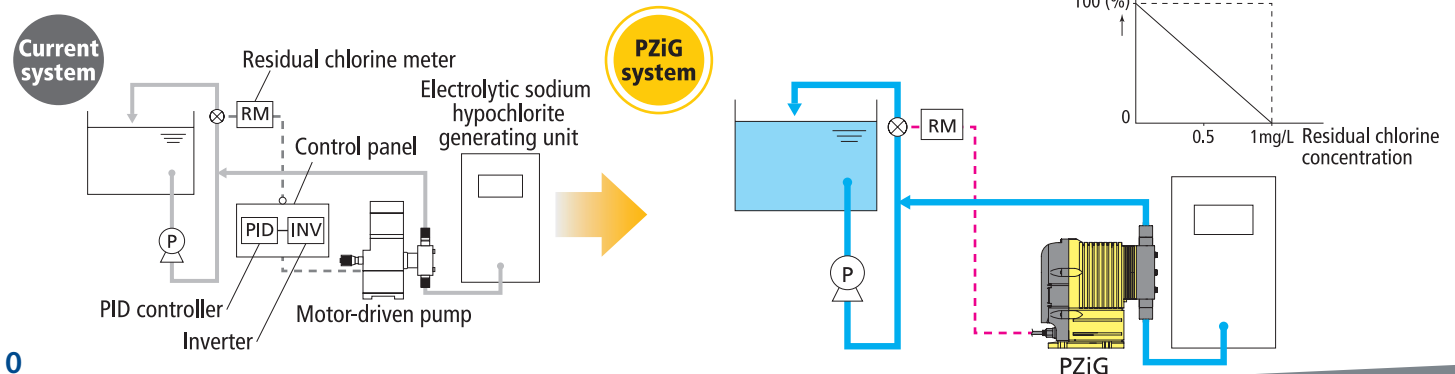

Multi-liquid Proportional Flow Rate Injection – Models PZi8* & PZiG

Advantage

Multiple PZiGs inject different chemicals according to preset values while calculating the signal from a single flow meter. This eliminates the need for a signal distributor.

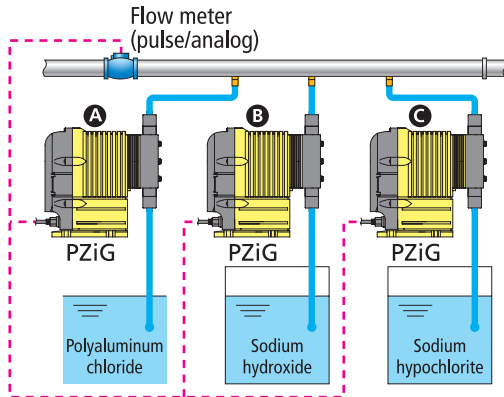

* Input is connected to one PZi8 pump: Multiple PZi4 pumps would follow the pulse output of the PZi8 pump.

Note:

Multiple PZiG pumps take pulse or analog signal directly: A single PZi8 pump would take a pulse or analog signal directly and slave a second or third pump to its output.

2-point Level Switch-based Control – Models PZi8 & PZiG

Advantage

A 2-point level control enables output of an alarm at the liquid level "low limit" and stops pump operation at the "low-low limit."

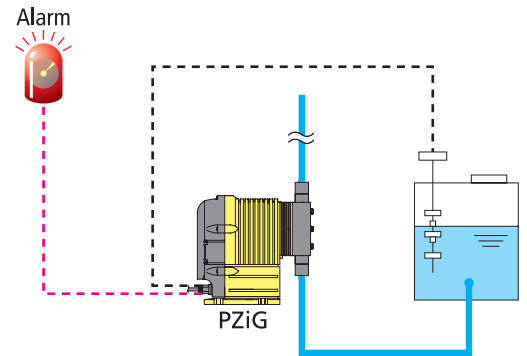

Batch Injection (counter)* – Models PZi8 & PZiG

Advantage

Pump operation starts on command signal. Operation automatically stops and operator is notified of completion when a preset count is reached. Maximum number of pulses 9999 x 1, x10, x100 or x1000 (555 hours max. run time).**

* Calibration function ensures accuracy greater than ordinary pumps in these applications (see page 3).

** Pump operation can be interrupted by a remote signal at any time; program resumes when restarted.

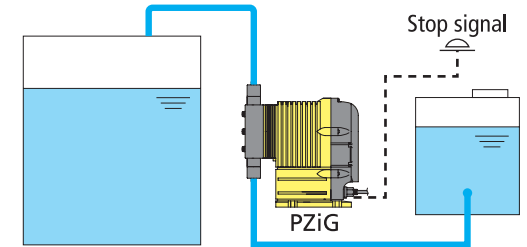
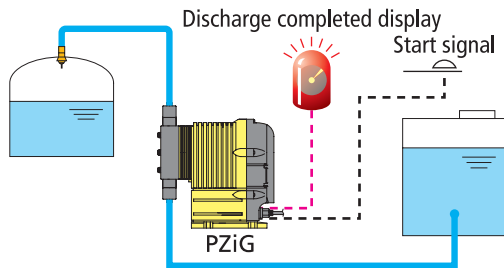

CONTROL VARIATIONS – Models PZi8 & PZiG

Basic specifications	Adjustment range		Stroke speed	1~300 spm (1 spm step)	
			Stroke-length adjustment	20%~100%*	
	Number of inputs	Analog input 4~20 mADC (110 ohm)		1	
		Digital input high speed (125 Hz max.) Open collector		2	
Digital input low speed (10 Hz max.) Open collector		2			
Other	Power supply output +5VDC (10 mA max.)		1		
Run mode	LCD display	Display unit selection (% , mL, spm)			
	Manual operation	Manual mode			
	Automatic operation	Analog mode		Analog signal	4~20 mADC
		Pulse signal			1 / 1~1/ 9999
		Pulse signal			1 to 9999 times
		Count mode	Number of strokes	1~9999 (x1, 10, 100, 1000)	
Interval mode	ON/OFF time	1 to 9999 mins / 1 to 9999 mins			

*50~100% for sizes -31/ -61/ -12

Inputs	Stop input	
	Control input	Level switch input
		Alarm reset input
Start/reset input		
Outputs	Control output	Operation signal output
		Operation sync pulse output ¹
	Alarm output	End signal output ²
		Analog input error alarm ³
Inpule pulse buffer overflow alarm ³		
Level error alarm ³		
Injection monitor error alarm ³		

1. Output in sync with solenoid operation.

2. Output when operation for preset count is completed.

3. Alarm display, alarm output and pump operation can be selected in response to an alarm condition.

Quality Accessories by Neptune



Corporation Stops

MODEL CS2-75-PVC-NL

Use: Injection of chemicals pumped by metering pumps into tanks, mains, cooling towers and process systems.

Request Bulletin CS

MODEL	MATERIAL OF CONST.	SIZE (A)	DIMENSIONS		
			B	C	D
CS2-75-PVC-NL	CPVC	3/4" NPT	7 3/4"	5 1/4"	2"
CS2-100-PVC-NL	CPVC	1" NPT	7 1/4"	6 1/4"	1 1/2"

Kynar, 316SS and C-20 also available.

Portable Mini-Tank Feeders

MODEL MT-30

Mini-tank system offers portability and economy. Compact 23 1/2" wide, 36" long, 29" high size fits through doorways, in elevators and allows installation in small areas. Tank removes from base for ease of transport and handling.

- Total weight: 40 lbs. plus pump
- Use with electronic or motor-driven pumps
- 8" manway standard

Request Bulletin FDP/CFS

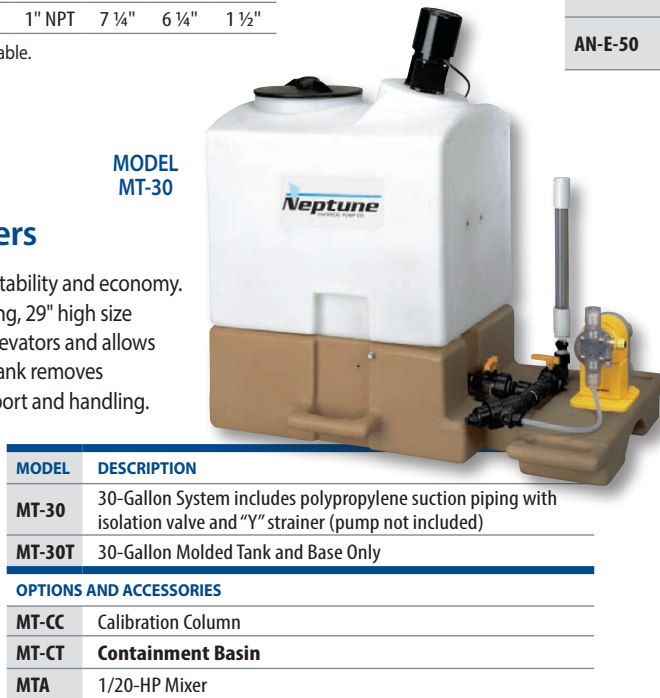

MODEL	DESCRIPTION
MT-30	30-Gallon System includes polypropylene suction piping with isolation valve and "Y" strainer (pump not included)
MT-30T	30-Gallon Molded Tank and Base Only
OPTIONS AND ACCESSORIES	
MT-CC	Calibration Column
MT-CT	Containment Basin
MTA	1/20-HP Mixer

Specifications and dimensions for the products in this bulletin are subject to change without notice.

Polyethylene Solution Tanks and Agitators For PZ Series Pumps (Top-Mounted)

- Self Supporting
- For Corrosive or Non-Corrosive Solutions
- Molded cover will accept "PZ" Series Pumps and Neptune Economy Agitators
- 30- or 50-Gallon Sizes



MODEL ST-50

TANKS

MODEL	SIZE	HEIGHT	DIA. MAX.	WEIGHT
ST-30	30 Gal.	23"	22"	19 lbs.
ST-50	50 Gal.	32 1/2"	22"	20 lbs.

AGITATORS – PVC suction tubing protector pipe included

MODEL	DESCRIPTION	WEIGHT
AN-316-30	316SS shaft and propeller, fits 30-gallon polyethylene tank; 19" long shaft	14 lbs.
AN-316-50	316SS shaft and propeller, fits 50-gallon polyethylene tank; 29" long shaft	14 lbs.
AN-E-30	Epoxy-coated shaft and impeller, fits 30-gallon polyethylene tank; 19" long shaft	14 lbs.
AN-E-50	Epoxy-coated shaft and impeller, fits 50-gallon polyethylene tank; 29" long shaft	14 lbs.

Nimble Skid Flexible Pump Packages

Nimble Skids offer a complete chemical feed system ready for use with bulk or semi-bulk tanks. Standardized design with a menu of options allows design flexibility and rapid delivery at an affordable cost. Controls and Automation are available.

Request Bulletin FDP/CFS



Where Innovation Flows



PSG
22069 Van Buren Street
Grand Terrace, CA 92313-5607 USA
P: +1 (215) 699-8700 • F: +1 (215) 699-0370
neptune1.com

PSG reserves the right to modify the information and illustrations contained in this document without prior notice. This is a non-contractual document. 05-2018

Authorized PSG Partner:



Missouri Filter & Process Equipment Co
MOFILCO-Quality, Value, Service
12025 Manchester Road, Suite 30G
St Louis MO 63131

314-821-4321 www.mofilco.com
mofilco@mofilco.com